

This drawing is copyright. Information contained thereon is supplied in confidence and must not be used for any other purpose than which it was supplied, or be reproduced without written permission of the owners.

type : 11 SMA-50-3-15 / -65

	date	sign
drawn	09.02.99	4728/TuB
checked	12.94	4301
approved	9.2.99	7324

cable shortening dimension

scale 3:1

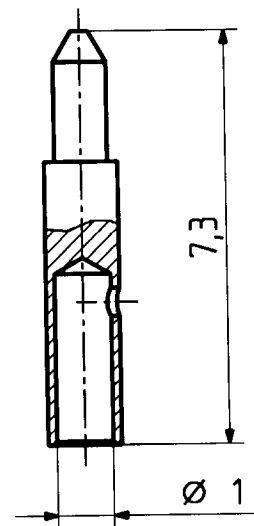
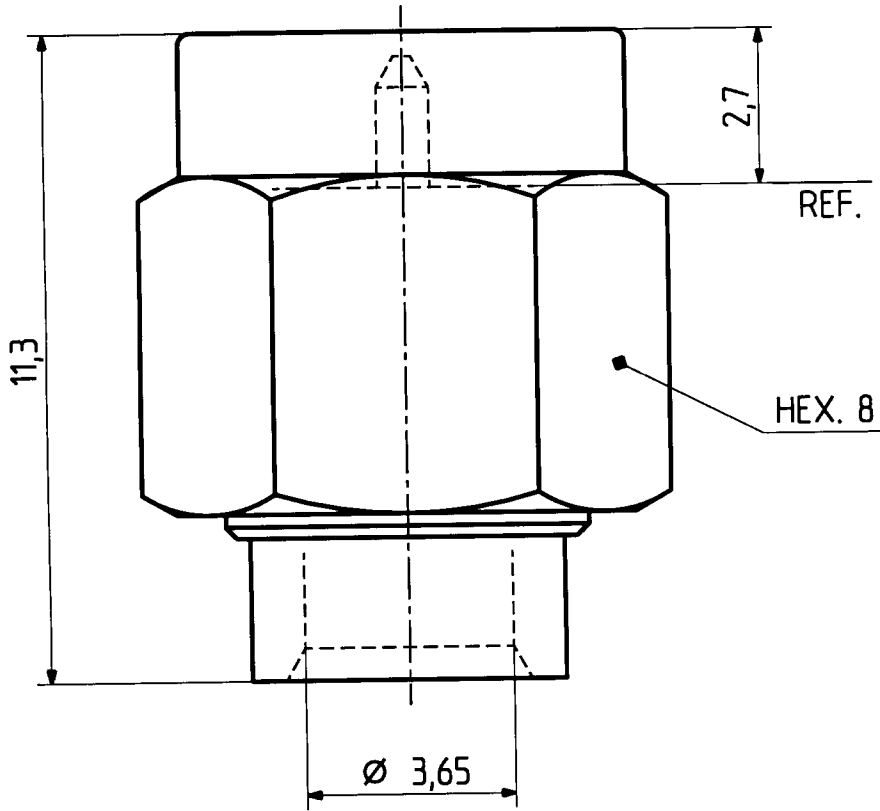
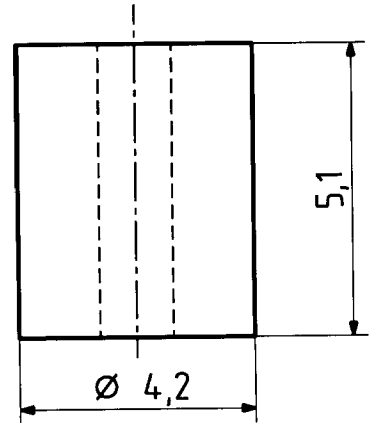
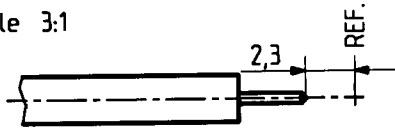

Diese Zeichnung ist unser geistiges Eigentum und darf ohne unsere ausdrückliche Einwilligung weder kopiert, vervielfältigt, noch Drittpersonen oder Konkurrenzfirmen zugänglich gemacht werden.

H+S 701 4.48.05

scale

8 : 1



HUBER + SUHNER RFX

dimensions in mm

drawing number

4.13.01077

OZ drawing :

Index

b