

Wherever shielded cables and wires are fitted, there is the problem of finding a permanent, repeatable, safe and quick connection of the braided shield.

Conventional connection methods use soldering, which is more time-consuming and more expensive, and can often result in damage to the dielectric or to the internal shield conductor caused by heat. Moreover, the use of lead-based soldering methods can be in conflict with the latest European regulations.

The Shield-Kon® solution from Thomas & Betts involves a crimp technique for shield termination on shielded cables. The reliability of Shield-Kon® terminals has led to a specification for the aeronautical and space technology industry and for military applications (MIL-F-21608).

Thomas & Betts offer two solutions:

- The one-piece Shield-Kon® connector, which is wrapped around the shield during the crimping process.
- The two-piece Shield-Kon® connector, which consists of two sleeves, between which the shielded braid and the drain wire are compressed.

The essential advantages are clearly visible:

- Saves time and reduces assembly costs
- Safe monitoring
- Simple operation
- Low profile and compact connectors
- Tried and tested technology
- Constant connections of consistent quality



Shield-Kon®

One-piece connector: Overview

This solderless, wrap-around connector terminates shielded cable in seconds ... with uniform precision. It is particularly well suited for production work in aircraft, aerospace and electronic industries where size and weight are of importance.

Once crimped, it provides a compact, lightweight, low resistance, high strength connection, which meets and exceeds the performance requirements of MIL-F-21608.

The connector works equally well on braided, wrapped, or foil shields and has the added advantage of being able to be used as a mid-span termination.

Only four sizes, which can be easily identified by the colour of their insulation, are needed to cover a range of shielding diameters from 1.27 mm to 7.62 mm.

Features & Benefits

- Compact, low profile connector
- One piece "Wrap-around" design
- Tough Polyester insulation (Mylar® -type)
- Inventory savings: only 4 sizes
- Transparent insulation, easily inspected
- MIL specified, industry approved technology
- NO HEAT OR POWER REQUIRED to install
- No damage to inner conductor
- Less installation time required
- Uniform, precise connection every time
- Low installed cost
- Mid-span termination possible, eliminating the need to demount a cable already installed



The one-piece Shield-Kon® connectors meet the MIL-F-21608 standards for the following environmental specifications:

Technical Information

Voltage drop	9 mV max. at 1 Ampere after environmental exposure
Plating	Electro-deposit tin in accordance with MIL-T-10727A
Insulation dielectric strength	500 VRMS at 60 Hz for one minute
Corrosion resistance	48 hours in 5% salt fog
Pullout strength	67 N min. with 0.25 mm ² drain wire and 85N min. with 0.5 mm ² drain wire
Vibration	0.76 mm double amplitude between 10 and 55Hz for 6 hours on each of two axis

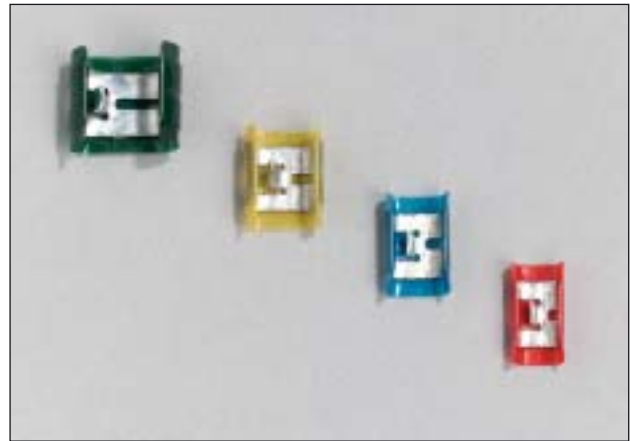

Technical Information:



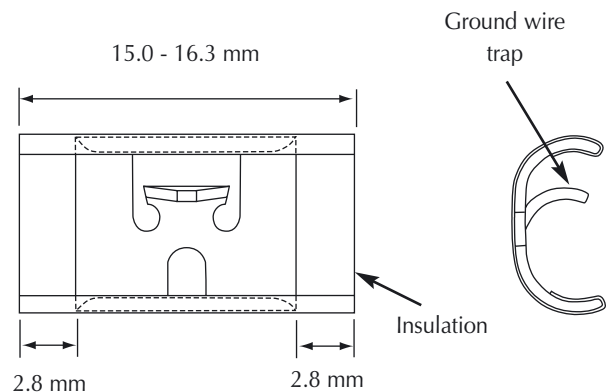

One-piece Shield-Kon® connectors

Material	Copper, conform to CDA No. 110
Plating	Tin, electro-plated (thickness 3 to 8 µm), in accordance with MIL-T-10727A
Insulation	Polyester film (Mylar® type), colour coded for size identification
Temperature	-65°C to +125°C

Mylar® is a registered trade mark of Du Pont de Nemours



Ordering Information: one-piece Shield-Kon® connectors

	PRODUCT REF.	COLOUR	SHIELD DIAMETER RANGE [mm]	ACCEPTABLE DRAIN WIRE SIZE**	QUANTITY [pieces]	INSTALLATION TOOL*
	RSK101	red	1.27 - 2.28	1 or 2 pieces 0.25mm ²	1000	
	RSK5101				100	
	RSK201	blue	2.29 - 3.65	1 or 2 pieces 0.25mm ² , or 1 piece 0.5mm ²	1000	WT740
	RSK5201				100	ERG740
	RSK301	yellow	3.66 - 5.12	1 or 2 pieces 0.25mm ² , or 1 piece 0.5mm ²	1000	13300-TB
	RSK5301				100	
	RSK401	green	5.13 - 7.62	1 or 2 pieces 0.5mm ² , or 1 piece 0.75mm ²	1000	
	RSK5401				100	

(*) See pages 369 to 372 for tooling specifications and for die selection

(**) Alternatively, a special accessory (RSK-flag) can be used in place of the drain wire, with the yellow and the green connectors (see below)

Note: the connectors can also be supplied on reel for high volume applications with semi-automatic machine (see page 372)

Accessories: the RSK-FLAG connector

- The RSK-FLAG is inserted into the one-piece Shield-Kon® connector and replaces the drain-wire
- Easy & direct connection of the RSK-FLAG to a piece of earthed equipment thanks to the installation hole
- Available in 3 sizes of hole
- To be used with the RSK-301 (yellow) or RSK-401 (green) connectors

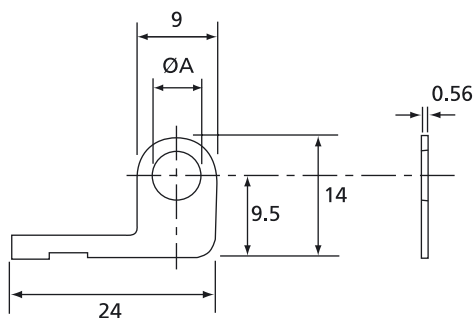

Technical Information: the RSK FLAG

Material	Electrolytic copper
Plating	Zinc alloy

Ordering Information for the RSK FLAG

PRODUCT REF.	TERMINATION SCREW SIZE ØA	WEIGHT [g/100]	QUANTITY [pieces]
RSK-FLAG-B3	M3	75	1000
RSK-FLAG-B4	M4	75	1000
RSK-FLAG-B5	M5	75	1000

Installation methods

Standard method

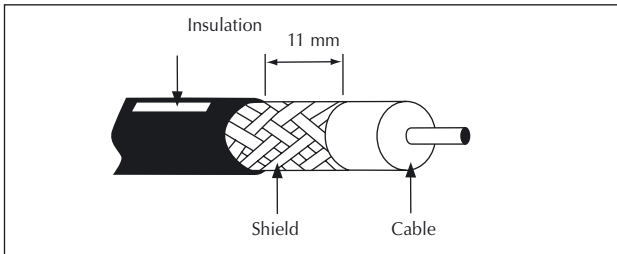

Use the standard method when the shielded cable or the inner conductors are embedded in a dielectric.

Mid-Span method

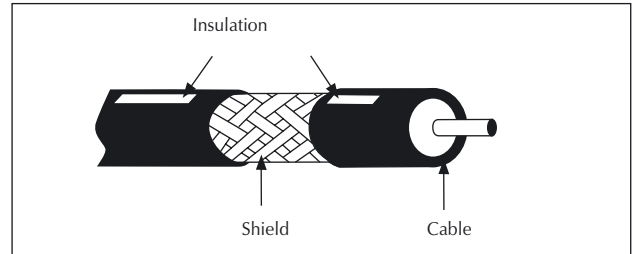

Allows installation anywhere along the cable.

Fold-back method 1

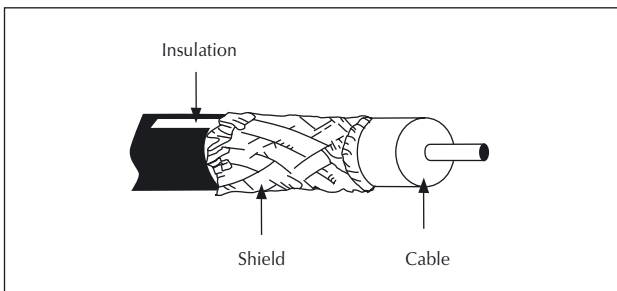

If there is no common dielectric for several interior cables but the gaps are filled by textile threads or something similar, care should be taken to ensure that the insulating thickness of the individual cables is not less than 0.38 mm for PVC, and not less than 0.25 mm for Teflon. If this insulation thickness falls below this value, fold-back method 1 should be used.

Fold-back method 2

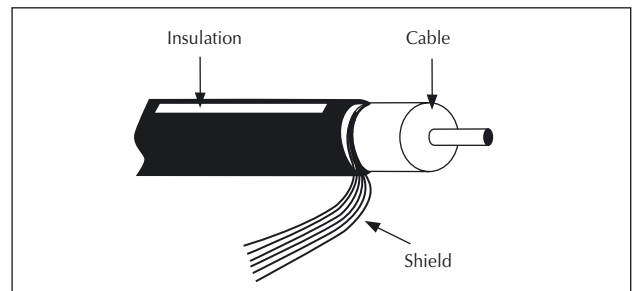

Fold-back method 2 should be used if the cable shield is applied spirally or if a foil shield is being used.

One-piece connector: Installation methods and procedure

Installation procedures

Step 1

Prepare shielded wire and drain wire insulation as shown. If two earth wires are required in a Shield-Kon® connection, twist both conductors before insertion into the connector.

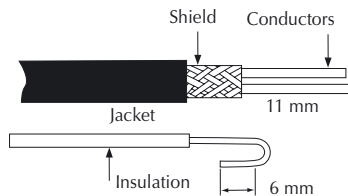

Step 2

Select the appropriate connector according to the size of the shielded cable (see page 368). Place the drain wire around the trap hook and the shielded wire into the bottom of the connector. When inserting the shielded cable and grounding wire, care must be taken to ensure that their insulation is overlapped by the connector's Polyester insulation film.

100% insulation is possible after crimping when the stripped length of outer jacket (visible shielding) is 11 mm maximum.

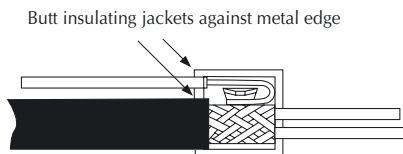

Step 3

Select the appropriate die set for the crimp tool, according to the size of the shielded cable (see page 368) and mount the dies on the tool. Insert the connector (with the shielded cable and the drain wire) between the dies of the tool.

Squeeze the tool handles firmly to crimp the connector around the shielding and the drain wire.

Connector opening faces away from tool

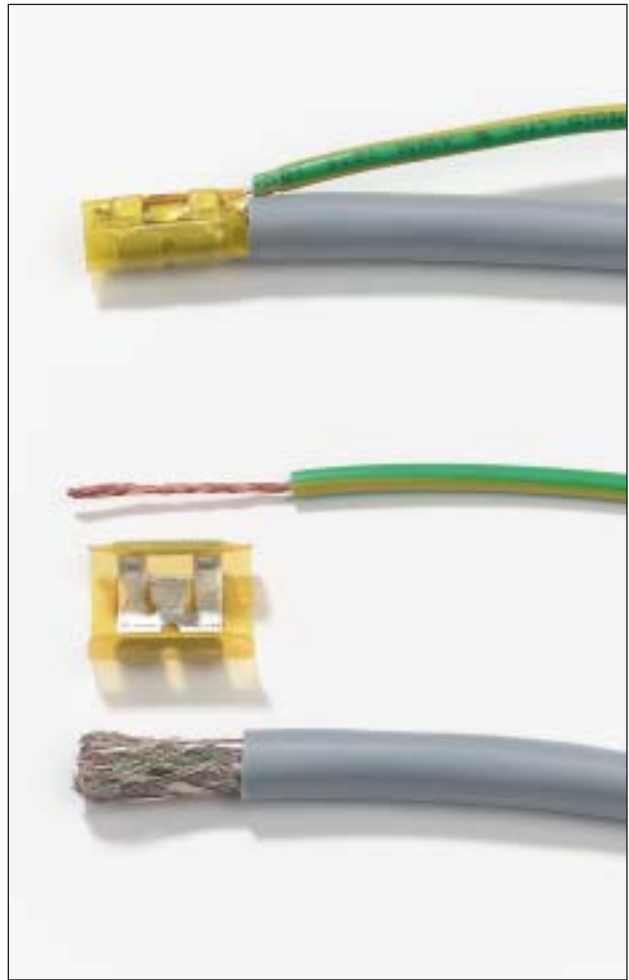
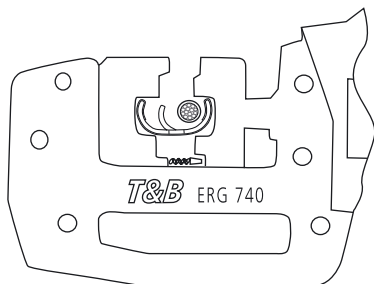

Shield-Kon®

One-piece connector kits

Product Ref.: RSK-SET

The Shield-Kon® connection system is now available as a comprehensive kit in a robust thermoplastic case which provides all you need to be efficient in the field without any additional tooling.

The case (Product Ref. RSK-SET) contains:

- 1 ergonomic hand tool (Product Ref. ERG-740)
- 1 gauge (Product Ref.) RSK-LEHRE for instant selection of the die and the connector to be used
- All the 13 plastic dies (Product Ref. 101A to 401M, see page 370) to cover a wide range of shielded cable diameters
- 100 pieces of RSK101 (red) connectors
- 100 pieces of RSK201 (blue) connectors
- 100 pieces of RSK301 (yellow) connectors
- 100 pieces of RSK401 (green) connectors

Dimensions of plastic case (L x W x H): 320 x 260 x 75 mm

Weight of plastic case with content: 2.2 kg



Product Ref.: RSK-SET-IT

Same as Product Ref. RSK-SET, but with a smaller range of plastic dies.

The case (Product Ref. RSK-SET-IT) contains:

- 1 ergonomic hand tool (Product Ref. ERG-740)
- 1 gauge (Product Ref. RSK-LEHRE) for instant selection of the die and the connector to be used
- 1 bench-mount stand
- 4 plastic dies (Product Ref. 101A, 201D, 301G, 401K)
- 100 pieces of RSK101 (red) connectors
- 100 pieces of RSK201 (blue) connectors
- 100 pieces of RSK301 (yellow) connectors
- 100 pieces of RSK401 (green) connectors

Dimensions of plastic case (L x W x H): 320 x 260 x 75 mm

Weight of plastic case with content: 2 kg

One-piece connector: Connector and die selection

Product Ref.: RSK-LEHRE

The choice of the appropriate connector and die set mainly depends on the size of the shielded cable.

The selection can be done very quickly with the RSK-LEHRE gauge.

1. Remove the outer jacket from the shielded cable, making the shielding visible
2. Insert this stripped end of the cable into the slots located around the gauge. The correct slot will be found when the cable can slide only in the upper part of the slot. If the cable can slide completely to the bottom of the slot, you should try with the smaller adjacent slot.
3. Once the appropriate slot is found, the corresponding RSK connector is defined by the colour of the strip around the slot, whereas the corresponding plastic die set is given by the number marked below the slot (for the metal die set, add prefix "D" to this number)
4. The following table summarises the different combinations of connector / die set, as well as the size of drain wire that can be used



One-piece Shield-Kon® connectors & die selection table

PRODUCT REF.	COLOUR	SHIELD DIAMETER [mm]	PLASTIC DIES FOR 13300-TB WT-740 AND ERG-740	METAL DIES FOR ERG-740	ACCEPTABLE DRAIN WIRE SIZE
RSK 101	red	1.27-1.79	101A	D-101A	1 or 2 pieces 0.25mm ²
		1.80-2.28	101B	D-101B	
RSK 201	blue	2.29-2.55	201C	D-201C	1 or 2 pieces 0.25mm ² or 1 piece 0.5mm ²
		2.56-3.00	201D	D-201D	
		3.01-3.34	201E	D-201E	
		3.35-3.65	201F	D-201F	
RSK 301	yellow	3.66-4.13	301G	D-301G	1 or 2 pieces 0.25mm ² or 1 piece 0.5mm ²
		4.14-4.71	301H	D-301H	
		4.72-5.12	301J	D-301J	
RSK 401	green	5.13-5.86	401K	D-401K	1 or 2 pieces 0.5mm ² or 1 piece 0.75mm ²
		5.87-6.36	401L	D-401L	
		6.37-7.00	401M	D-401M	
		7.01-7.62	401N	D-401N	

Standard hand tool

Product Ref.: WT740

- Standard hand tool
- MIL specified
- Robust construction: metallic frame, partially covered with plastic
- Can be used only with plastic dies (see page 370)
- All the dies are easily interchangeable
- Parallel action crimp
- Shure-Stake™ mechanism: once pressing has commenced, the tool can be re-opened only after successful completion of the crimping cycle
- Supplied in a wood box containing 1 tool (dies to be ordered separately)



Dimensions of tool (L x W x H): 254 x 97 x 12 mm
Weight of tool: 795 g

Ergonomic hand tools

Product Ref.: ERG-740

- Ergonomic hand tool
- Robust construction: metallic frame, partially covered with plastic
- Can be used either with plastic dies (see page 370) for small volume or with metal dies (see page 371) for medium to high volume applications
- All the dies are easily interchangeable (to be ordered separately)
- Parallel action crimp
- Shure-Stake™ mechanism: once pressing has commenced, the tool can be re-opened only after successful completion of the crimping cycle
- Supplied in a plastic case with:
 - 1 tool
 - 1 bench-mount stand for easier use in volume production
 - 1 gauge (Product Ref. RSK-LEHRE) for instant selection of the die and the connector to be used



Dimensions of tool (L x W x H): 210 x 155 x 25 mm
Weight of tool: 470 g
Dimensions of plastic case (L x W x H): 245 x 210 x 55 mm
Weight of plastic case with content: 930 g

Product Ref.: ERG740-01

Same as ERG-740, but supplied in a plastic case with:

- 1 tool
- 1 bench-mount stand for easier use in mass production
- 1 RSK-LEHRE gauge for instant selection of the die and the connector to be used
- 1 metal die D-101A
- 1 metal die D-201C
- 1 metal die D-301J
- 1 metal die D-401M



Dimensions of plastic case (L x W x H): 245 x 210 x 55 mm
Weight of plastic case with content: 1200 g

One-piece connector: Tooling**Pneumatic tool****Product Ref.: 13300-TB**

- Air-operated pressure tool
- Installs one-piece Shield-Kon® connectors to shielded cable in seconds
- Can be used only with the plastic dies (see table below)
- Hand-actuated switch or optional foot-actuated switch
- Operation is quick and easy (detailed instructions enclosed with the tool)
- Accessory: **Product Ref. 13301** = bench mount kit with footswitch

Plastic dies

- Ideal for small volume productions (up to a few hundred cycles maximum): prototyping, repair, etc
- Made of high quality polymer, in the same colour as the corresponding connector
- Go / no-go gauges available (to be ordered separately) to inspect the wearing condition
- Can be mounted on ERG740, WT740 and 13300-TB tools
- The Product Ref. is marked on the upper part and on the lower part of the die set
- Packaging: 1 die set in a plastic box with Euroslot
- Weight: approx. 20 g (33 g with the packaging)
- Packaging size (L x W x H): 40 x 25 x 70 mm

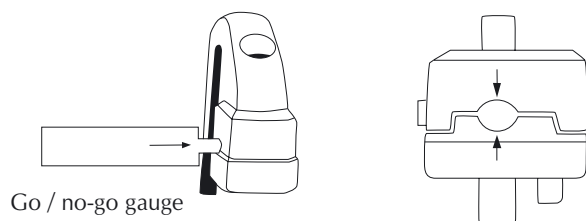
**Technical Information**

Operating pressure	4.1 - 5.5 bar (60-80 psi) with a maximum of 8.3 bar (120 psi)
Output force	5360 N at 120 psi
Piston stroke	1.3 cm minimum
Finish	Anodise
Weight	1.4kg
Air hose length	2.44 m
Air hose coupling	Hansen "13"

**Ordering Information: plastic dies for 13300-TB, ERG740 and WT740**

DIE PRODUCT REF.	DIE COLOUR	SHIELD DIAMETER [mm]	FOR CONNECTOR	GAUGE PRODUCT REF.
101A	red	1.27 - 1.79	RSK 101 red	101AG
101B	red	1.80 - 2.28	RSK 101 red	101BG
201C	blue	2.29 - 2.55	RSK 202 blue	201CG
201D	blue	2.56 - 3.00	RSK 202 blue	201DG
201E	blue	3.01 - 3.34	RSK 202 blue	201EG
201F	blue	3.35 - 3.65	RSK 202 blue	201FG
301G	yellow	3.66 - 4.13	RSK 301 yellow	301GG
301H	yellow	4.14 - 4.71	RSK 301 yellow	301HG
301J	yellow	4.72 - 5.12	RSK 301 yellow	301JG
401K	green	5.13 - 5.86	RSK 401 green	401KG
401L	green	5.87 - 6.36	RSK 401 green	401LG
401M	green	6.37 - 7.00	RSK 401 green	401MG
401N	green	7.01 - 7.62	RSK 401 green	401NG

Metal dies

- For mass production and medium to high volumes
- Made of hardened steel, does not wear
- Only for the ERG740 hand tool
- The Product Ref. is engraved on the upper part and on the lower part of the die set
- Marked with a dot having the same colour as the corresponding connector
- Packaging: 1 die set in a cardboard box with Euroslot
- Weight: approx. 75 g
- Packaging size (L x W x H): 45 x 45 x 70 mm



Ordering Information: metal dies for ERG-740

DIE PRODUCT REF.	DIE COLOUR	SHIELD DIAMETER [mm]	FOR CONNECTOR
D-101A	red	1.27 - 1.79	RSK 101 red
D-101B	red	1.80 - 2.28	RSK 101 red
D-201C	blue	2.29 - 2.55	RSK 202 blue
D-201D	blue	2.56 - 3.00	RSK 202 blue
D-201E	blue	3.01 - 3.34	RSK 202 blue
D-201F	blue	3.35 - 3.65	RSK 202 blue
D-301G	yellow	3.66 - 4.13	RSK 301 yellow
D-301H	yellow	4.14 - 4.71	RSK 301 yellow
D-301J	yellow	4.72 - 5.12	RSK 301 yellow
D-401K	green	5.13 - 5.86	RSK 401 green
D-401L	green	5.87 - 6.36	RSK 401 green
D-401M	green	6.37 - 7.00	RSK 401 green
D-401N	green	7.01 - 7.62	RSK 401 green

One-piece connector: Tooling**Semi-automatic machine**

For high volume applications, the one-piece Shield-Kon® connectors can also be supplied on reels, for an installation with the semi-automatic machine WT-EWCT20.

Product Ref.: WT-EWCT20

- Semi-automatic tool for mass production
- Terminates shields on round cables
- For one-piece Shield-Kon® connectors on reel (red, blue, yellow, green) for shield diameters from 1.27 mm to 7.62 mm
- The connectors on reel have the same technical specifications as the loose piece connectors
- Each colour coded connector on reel is crimped with its appropriate adaptor and die set - see selection table
- The selection of the connector can also be done with the RSK-Lehre gauge (see page 368)
- Computer controlled quality
- The crimp pressure and quantity are displayed
- Built-in crimp test facility
- Compact desktop design

**Technical Information**

Operating voltage & frequency	220 - 240 V, 50Hz
Activation	Foot controlled switch (pedal)
Performance	Up to 450 crimps per hour

According to the connector size, which depends on the shielded cable size, the WT-EWCT20 machine requires an adaptor set and a die set that can be selected in the table below.

Ordering Information: selection table for one-piece Shield-Kon® on reel

PRODUCT REF.	COLOUR	REEL QUANTITY [pieces]	SHIELD DIAMETER [mm]	TOOL DIES	DIE ADAPTOR	DRAIN WIRE (BRAID)
RSK 101 F	red	5000	1.27-2.28	WT-ECT101A	WT-ECT11	1 or 2 pieces 0.25mm ²
RSK 201 F	blue	3000	2.29-3.65	WT-ECT201D	WT-ECT12	1 or 2 pieces 0.25mm ² or 1 piece 0.5mm ²
RSK 301 F	yellow	2000	3.66-5.12	WT-ECT301G	WT-ECT13	1 or 2 pieces 0.25mm ² or 1 piece 0.5mm ²
RSK 401 F	green	1400	5.13-7.62	WT-ECT401K	WT-ECT14	1 or 2 pieces 0.5mm ² or 1 piece 0.75mm ²

Shield-Kon®

Two-piece connector: Overview

The Shield-Kon® two-piece shield termination system from Thomas & Betts consists of 2 cylindrical sleeves: an inner sleeve, with a smaller diameter, and an outer sleeve, which has a larger diameter but which is shorter and less hard than the inner sleeve. All inner and outer sleeves are colour-coded according to their size.

The conductors of the cable are inserted through the inner sleeve, whereas the shield (braided or foiled) and the drain wire are inserted between the 2 sleeves. The crimp operation is done by compressing the outer sleeve with a tool, while the inner sleeve ensures a mechanical protection to the inner conductors.

This unique shield termination system can be used with cables having a diameter of dielectric (after removing the outer insulation and the shield) between 1.1 mm and 73 mm.

In the **“Hexagonal Range”** (diameters of dielectric between 1.1 mm and 9.6 mm), the outer sleeve is crimped with a hand tool and the result is a hexagonal-shaped crimp. This range is used to crimp shielded and coaxial cables.

The **“Circular Range”**, for Multiple or Overall shielded cables, refers to larger diameters of dielectric (between 10 and 73 mm) and owes its name to the circular shape of the crimp.

Two-piece connector: the Hexagonal Range

The Thomas & Betts hexagonal compression (for diameters of dielectric up to 9.4 mm) is a reliable method for grounding, terminating and insulating shielded and coaxial cable.

It has literally hundreds of millions of installations in communications, aerospace, electronic, telephone, radio and TV applications.



Hexagonal range



Circular range

Two-piece connector: Installation methods in the Hexagonal Range

Three installation methods are possible in the hexagonal range, for a quick, neat and accurately completed termination...at a greatly reduced production cost.

Method 1: Standard

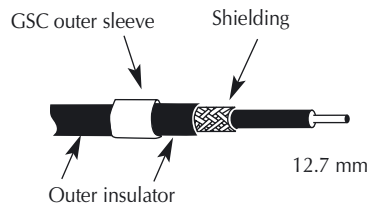

- A. After stripping the shield (13 mm in length), slip the outer sleeve over the outer insulation. If this is too big, slip the outer sleeve on, after method described in Fig. 3.



- B. Widen the braided shield by gently rotating the inner conductor, then slip the inner sleeve under the braided shield.



- C. Position the inner sleeve so that about 1.6 mm protrudes beyond the end of the braided shield.



- D. Slip the drain wire (0.25–0.5 mm²) under the outer sleeve (from the front or behind) and slip the outer sleeve over the braided shield.



- E. Position the outer sleeve and ensure that the ends of all wires in the braided shield and drain wire are covered. Crimp both sleeves with the correct tool and tool die. Finished.

Method 2:

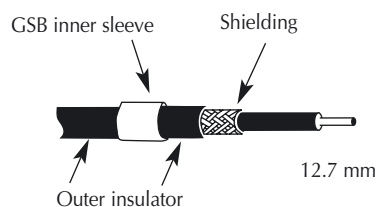

- A. After stripping the shield (13 mm in length), slip the inner sleeve over the outer insulation.

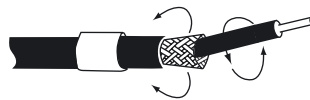

- B. Widen the braided shield by gently rotating the inner conductor.



- C. Fold back the braided shield over the inner sleeve and slip the outer sleeve over the braided shield



- D. Slip the drain wire (0.25–0.5 mm²) under the outer sleeve (from the front or behind) and slip the outer sleeve over the braided shield.



- E. Position the outer sleeve and ensure that the ends of all wires in the braided shield and drain wire are covered. Crimp both sleeves with the correct tool and tool die. Finished.

Method 3:

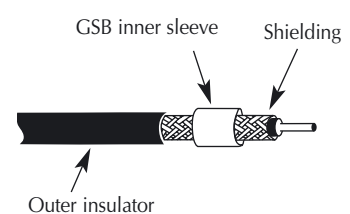

- A. After stripping the shield (25 mm in length), slip the inner sleeve over the braided shield

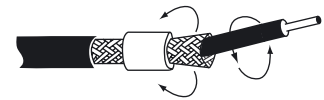

- B. Widen the braided shield by gently rotating the inner conductor.



- C. Fold back the braided shield over the inner sleeve and slip the outer sleeve over the braided shield



- D. Slip the drain wire (0.25–0.5 mm²) under the outer sleeve (from the front or behind) and slip the outer sleeve over the braided shield.



- E. Position the outer sleeve and ensure that the ends of all wires in the braided shield and drain wire are covered. Crimp both sleeves with the correct tool and tool die. Finished.

Two-piece connector: Connector and die selection in the Hexagonal Range

The choice of the appropriate combination of inner sleeve, outer sleeve and crimp tool / die will depend on the diameter of the dielectric.

However, a direct correlation with the diameter of the dielectric is not possible, as several different inner sleeves can be combined with the same outer sleeve (according to the type of shield).

With the directions shown below, a measuring instrument (calliper) is all that is required to make the right selection in 3 steps:

1. Selection of the inner sleeve (GSB)

- Strip the outer insulator and remove the shield
- Measure the maximum value of the diameter of the dielectric (diameter without shield) by gently rotating the cable. When doing so, it should be possible to turn the cable easily between the jaws of the calliper
- Add 0.13 mm to the measured value. The sum will give the Inner Diameter (I.D.) of the GSB inner sleeve
- In the table, select the GSB inner sleeve having this I.D. or the nearest larger I.D.

2. Selection of the outer sleeve (GSC)

Normal method:

- Slide the selected inner sleeve underneath the shield of the cable
- Measure the maximum diameter with the shield over the inner sleeve
- Add 0.8 mm to the measured value. The sum will give the Inner Diameter (I.D.) of the GSC sleeve
- In the table, select the GSC sleeve having this I.D. or the nearest larger I.D.

Quick method:

In most cases, a quicker method can be used to define the correct GSC outer sleeve:

- Once the appropriate GSB inner sleeve is found, the table will give the Outer Diameter (O.D.) of this GSB sleeve
- Add 1.5 mm to this O.D. and the sum will give the Inner Diameter (I.D.) of the GSC sleeve
- In the table, select the GSC sleeve having this I.D. or the nearest larger I.D.

3. Selection of the die

The Product Ref. for the appropriate die is given in the table hereafter, in the same row as the GSC sleeve that has just been defined and in the column of the chosen tool.

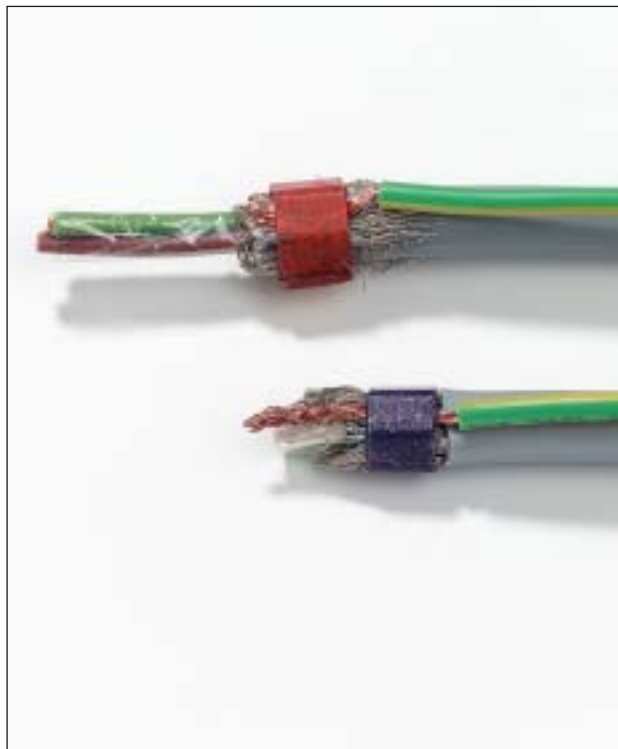

Two-piece connector: Connector and die selection in the Hexagonal Range



Technical Information: Inner sleeve

Material	Hard bronze
Finish	Tin plated (per MIL-T-10727A)
Length	7.9 mm

Technical Information: Outer sleeve

Material	Soft bronze
Finish	Tin plated (per MIL-T-10727A)
Length	6.4 mm

Ordering Information

PRODUCT REF.	COLOUR CODE	INNER DIAMETER [mm]	OUTER DIAMETER [mm]	PRODUCT REF. GSC	COLOUR CODE	INNER DIAMETER [mm]	OUTER DIAMETER [mm]	HAND TOOL	NEST NUMBER	HAND TOOL* WT440/WT540 MIL - SPEC.
INNER SLEEVES			OUTER SLEEVES			DIES				
GSB 046	Grey	1.17	1.90	GSC 101	Grey	2.56	3.16	D-419403	19	4419
GSB 058	Yellow	1.47	2.10	GSC 128	Blue	3.25	3.86	D-419403	00	4400
GSB 063	Red	1.60	2.23	GSC 149	Purple	3.78	4.54	D-419403	01	4401
GSB 071	Green	1.87	2.44	GSC 156	Yellow	3.96	4.90	D-419403	02	4402
GSB 080	Blue	2.00	2.63	GSC 175	Blue	4.40	5.46	D-419403	03	4403
GSB 090	Orange	2.20	2.90	GSC 187	Orange	4.75	5.76	D-406410	06	4406
GSB 096	Purple	2.44	3.02	GSC 194	Red	4.93	5.79	D-406410	06	4406
GSB 101	Yellow	2.56	3.16	GSC 199	Grey	5.05	5.97	D-406410	06	4406
GSB 109	Red	2.76	3.36	GSC 205	Yellow	5.20	6.22	D-406410	08	4408
GSB 115	Grey	2.92	3.70	GSC 219	Green	5.56	6.35	D-406410	08	4408
GSB 124	Green	3.14	3.68	GSC 225	Purple	5.71	6.50	D-406410	09	4409
GSB 128	Grey	3.25	3.86	GSC 232	Orange	5.90	6.70	D-406410	10	4410
GSB 134	Orange	3.40	4.00	GSC 261	Yellow	6.63	7.54	D-411414	11	4411
GSB 149	Blue	3.78	4.54	GSC 275	Grey	6.98	7.77	D-411414	12	4412
GSB 156	Red	3.96	4.90	GSC 281	Purple	7.14	8.40	D-411414	14	4414
GSB 165	Grey	4.20	4.92	GSC 287	Blue	7.29	8.30	D-411414	14	4414
GSB 175	Green	4.44	5.46	GSC 297	Green	7.54	8.50	D-411414	14	4414
GSB 187	Yellow	4.75	5.76	GSC 312	Yellow	7.92	9.20	D415417	15	4415
GSB 194	Blue	4.93	5.76	GSC 327	Grey	8.30	9.45	D415417	16	4416
GSB 205	Orange	5.20	6.22	GSC 348	Orange	8.84	9.98	D415417	17	4417
GSB 219	Grey	5.56	6.35	GSC 359	Purple	9.12	10.13	D-450451	50	5450
GSB 225	Yellow	5.71	6.50	GSC 375	yellow	9.12	10.13	D-450451	51	5451
GSB 232	Red	5.90	6.70	GSC 405	Red	10.28	11.50	D-452	52	5452
GSB 250	Green	6.35	7.14	GSC 415	Blue	10.54	11.76	D-454	52	5452
GSB 261	Blue	6.63	7.54	GSC 425	Grey	10.80	12.06	D-454	54	5454
GSB 266	Grey	6.75	7.54	GSC 460	Grey	11.68	12.95	ERG-5456**	56	5456
GSB 275	Orange	6.98	7.77	GSC 500	Green	12.70	14.60	ERG-5457**	57	5457
GSB 281	Yellow	7.14	8.40							
GSB 287	Grey	7.29	8.30							
GSB 297	Red	7.54	8.50							
GSB 312	Purple	7.92	9.20							
GSB 348	Orange	8.84	10.20							
GSB 375	Blue	9.52	10.30							

* Dies 4419 and 4400 to 4417 are for the hand tool WT440. Dies 5450 to 5457 are for the hand tool WT540

**Note: Product Ref. ERG-5456 and ERG-5457 are complete hand tools with pre-mounted die set

See pages 377 and 378 for tooling specifications

Standard packaging quantity: 1000 pcs. For 100 pcs packaging, add the code '5' in the Product Reference just after the "GSB" or "GSC" code

Example: GSC275 = 1000 pcs packaging, GSC5275 = 100 pcs packaging

Shield-Kon®

Two-piece connector: Tooling for the Hexagonal Range

Product Ref.: WT-440 and WT540

- Parallel action hand tool
- MIL-specified
- Frame, with the option of interchangeable steel dies
- A versatile tool, one frame with a selection of dies covers the whole range of shield diameters in the Hexagonal Range
- Shure-Stake™ mechanism: once pressing has commenced, the tool can be re-opened only after successful completion of the crimping cycle

Packaging: wood box containing 1 frame (dies to be ordered separately, see selection chart page 376 for Product References)

Product Ref.: ERG2000KE

- Ergonomic hand tool
- Frame, with the option of Interchangeable steel dies
- A versatile tool, one frame with a selection of dies covers a wide range of shield diameters in the Hexagonal Range, up to Product Ref. GSC425 outer sleeve
- Most dies have several nests (identified with a number) to allow the crimp of several GSC outer sleeves with the same die set. The appropriate nest number is shown in the selection chart (page 376)
- Shure-Stake™ mechanism: once pressing has commenced, the tool can be re-opened only after successful completion of the crimping cycle

Product Ref.: ERG5456

- Fixed die, ergonomic hand tool
- Designed to crimp the GSC460 outer sleeve
- Shure-Stake™ mechanism: once pressing has commenced, the tool can be re-opened only after successful completion of the crimping cycle
- Length: 252 mm
- Weight: 460 g

Packaging: cardboard box containing 1 tool with pre-mounted die set

Product Ref.: ERG5457

- Fixed die, ergonomic hand tool
- Designed to crimp the GSC500 outer sleeve
- Shure-Stake™ mechanism: once pressing has commenced, the tool can be re-opened only after successful completion of the crimping cycle
- Length: 252 mm
- Weight: 460 g

Packaging: cardboard box containing 1 tool with pre-mounted die set



Technical Information: WT-440

Length	203 mm
Weight	450 g
Dies	series 4400

Technical Information: WT-540

Length	264 mm
Weight	540 g
Dies	series 5450



- Length: 252 mm
- Weight: 460 g

Packaging: cardboard box containing 1 frame (dies to be ordered separately, see selection chart page 376 for Product References)

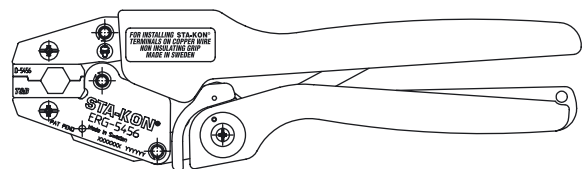

ERG5456

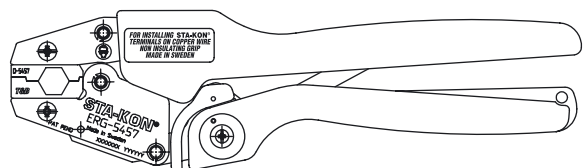

ERG5457

Two-piece connector: the Circular Range

The Shield-Kon® Connector System for multiple-conductor shielded cable is based on the principle of cold swaging. It uses a two-piece compression connector, which is colour-coded to match the proper die. The connector consists of a hard brass collector inner sleeve (ring) and a soft copper compression outer sleeve (ring). Each set of rings and matching installing die will connect a minimum of 5 shielding braids with one ground wire. The maximum number of braids is limited only by the space between the inner and outer rings.

The design advantages are:

1. Positive selection of inner and outer rings and installing die by a complete colour-coded system.
2. A more reliable grounding termination because only one ground wire connection is made - conventional daisy chain jumper method is eliminated.
3. Smaller, more compact bundle is easy to inspect.
4. Only one ground wire is required, however additional ground wires may be used if needed.
5. Smooth insulator protects conductor insulation.
6. With one stroke of the tool, the interlace die will produce a 360° compression uniformly securing all individual shields around the connector.

**Two-piece connector:
Installation method in the Circular Range**

1. After overall insulation is removed to expose shielded cables, each conductor must be freed from the shielding braid. The Thomas & Betts lead extractor tools (see page 380) simplifies this operation by pushing the inner conductor through an opening in the shielding braid. The braid is then folded back until all conductors are freed.

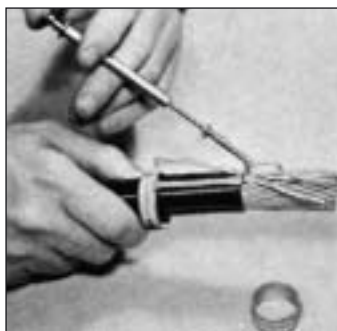

2. Flattened shielding braids are evenly distributed around the periphery of the GSB inner ring.

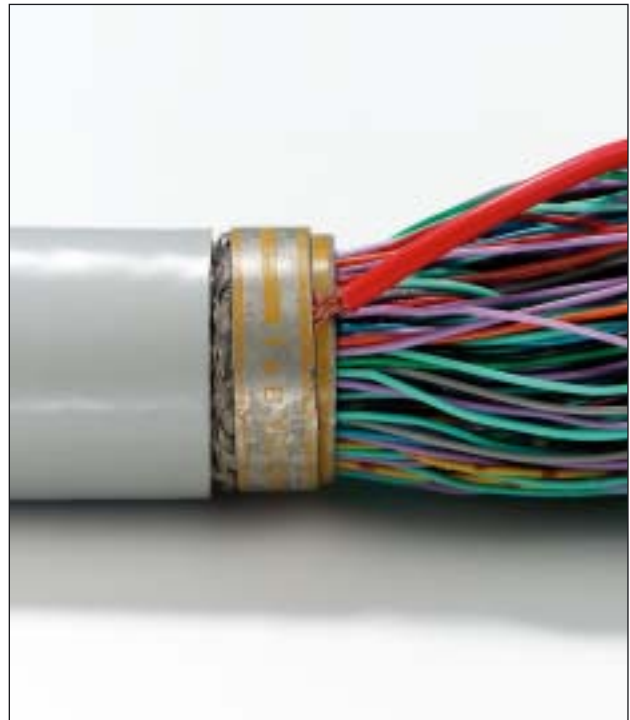

3. Position the GSC outer ring over the flattened shielding braid, locating it over the centre of the GSB inner ring. Braid may be trimmed even with the edge of the outer compression ring before or after compression. Ground wire or wires may be inserted between the outer ring and the shield prior to compression.



Two-piece connector: Connector and die selection in the Circular Range

The choice of the appropriate combination of inner ring, outer ring and crimp tool / die will depend on the overall diameter of the inner conductors (underneath the shield)

In the case of the Circular range, there is a direct correlation between the diameter of the inner conductors and the inner and outer rings.

With the directions shown below, a measuring instrument (calliper) is all that is required to make the right selection.

Selection of the GSB inner ring

- Measure the maximum value of the overall diameter of the inner conductors (underneath the flattened shield) by gently rotating the cable. When doing so, it should be possible to turn the cable easily between the jaws of the calliper
- Add 0.13 mm to the measured value. The sum will give the Inner Diameter (I.D.) of the GSB inner ring
- In the table, select the GSB inner ring having this I.D. or the nearest larger I.D

Selection of the GSC outer ring and of the die

Once the appropriate GSB inner ring is found, the table hereafter immediately gives the corresponding GSC outer ring and the appropriate die for the 13640 hydraulic head.



Technical Information: Inner sleeve

Material	Copper alloy ASTM B135
Finish	Electro tin plated (per MIL-T-10727A)
Length	15.2 mm

Technical Information: Outer sleeve

Material	Copper ASTM B188
Finish	Electro tin plated (per MIL-T-10727A)
Length	11.2 mm

Ordering Information

PRODUCT REF.	COLOUR CODE	INNER DIAMETER [mm]	OUTER DIAMETER [mm]	PRODUCT REF.	COLOUR CODE	INNER DIAMETER [mm]	OUTER DIAMETER [mm]	HYDRAULIC CRIMP HEAD 13640 MIL-SPEC.
INNER SLEEVES			OUTER SLEEVES			DIES		
GSB 430	Red	10.92	12.70	GSC 590	Red	14.99	17.02	GS 590
GSB 550	Blue	13.97	15.75	GSC 710	Blue	18.03	20.07	GS 710
GSB 670	Grey	17.02	19.05	GSC 840	Grey	21.34	23.37	GS 840
GSB 810	Brown	20.57	22.35	GSC 1010	Brown	25.65	27.61	GS 1010
GSB 920	Green	23.37	25.40	GSC 1130	Green	28.70	30.73	GS 1130
GSB 1040	Pink	26.42	28.45	GSC 1250	Pink	31.75	33.78	GS 1250
GSB 1122	Orange	28.50	30.28	GSC 1332	Orange	33.83	35.87	GS 1332
GSB 1224	Purple	31.09	32.87	GSC 1440	Purple	36.58	38.61	GS 1440
GSB 1353	Yellow	34.37	36.14	GSC 1563	Yellow	39.70	41.73	GS 1563
GSB 1425	Red	36.20	39.24	GSC 1670	Red	42.42	44.45	GS 1670

Standard packaging quantity: 1000 pcs

for 100 pcs packaging, add the code "5" in the Product Reference just after the "GSB" or "GSC" code

Example: GSB430 = 1000 pcs packaging, GSB5430 = 100 pcs packaging

Two-piece connector: Tooling for the Circular Range

Lead extractors

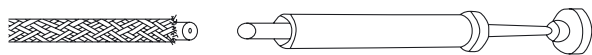

After the insulation is stripped off, flare the exposed braid. Push the flared end of braid back causing the braid to bulge.

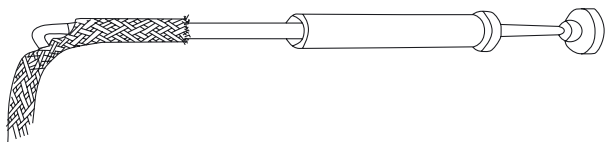

Retract the plunger and slide the tube over the wire until the desired breakout point is reached.

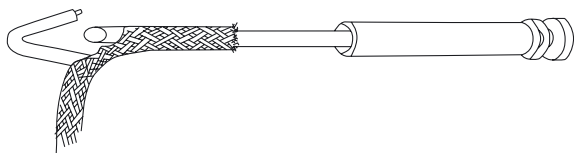

Hydraulic head

All the 2-piece Shield-Kon® in the circular range need to be crimped with the 13640 hydraulic head equipped with the appropriate die.

Product Ref.: 13640

- Hydraulic tool head
- 3.5 ton nominal pressure (output)
- For 2-piece Shield-Kon® terminals in the circular range
- Pioneer coupling, for quick assembly
- Requires a 9800 PSI (approx. 690 bar) operating service pressure (input)
- Quickly interchangeable steel dies (to be ordered separately, see page 379 for die selection)
- Length: 400 mm approx.
- Weight: 5.5 kg approx.

Ordering Information

LEAD EXTRACTOR PRODUCT REF.	FOR LEAD DIAMETER UP TO [mm]	PLUNGER COLOUR-CODE
WT-045B	1.14	Red
WT-060W	1.57	White
WT-080G	2.36	Blue
WT-100B	3.17	Green
WT-130Y	3.56	Yellow



Two-piece connector: Tooling for the Circular Range

Pumps

A small selection of pumps to operate the 13640 head is shown below (please contact your Sales Office for availability of other types of pumps).

Product Ref.: 13810E

- Hydraulic pump, electrical power
- Service pressure (output): 700 bar
- Motor power: 1 1/2 HP - 12 Amp
- Voltage & frequency: 230V - 50 Hz
- Capability: 3800 cc / min at 14 bar
1000 cc / min at 560 bar
- Reservoir volume: 7.6 l
- Coupling: Pioneer fitting
- Dimensions (L x W x H): 275 x 381 x 522 mm
- Weight: 27 kg without oil

Accessories:

- **Product Ref. 13611:** hand switch
- **Product Ref. 13612:** foot switch
- **Product Ref. 13613:** hydraulic hose 1.82 m long, with Pioneer couplings
- **Product Ref. 21061:** hydraulic oil (0.95l can)

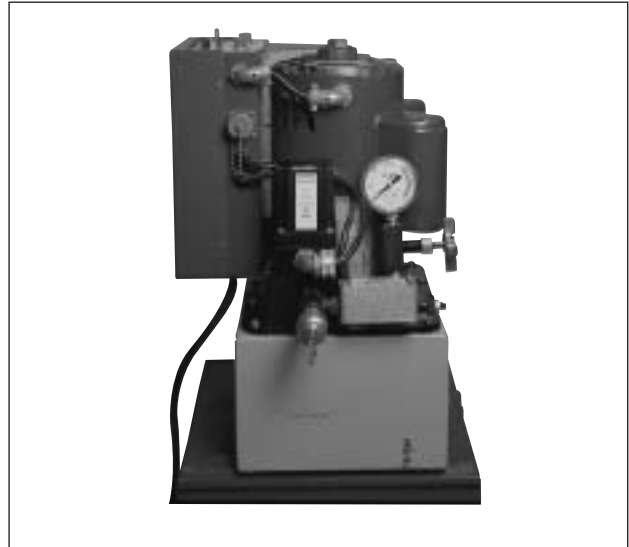

Product Ref.: 13606

- Hydraulic pump, foot (or hand) activated
- Service pressure (output): 700 bar
- Over-pressure security valves
- Coupling: Pioneer fitting
- Dimensions (L x W x H): 597 x 133 x 165 mm
- Weight: 10.4 kg

Accessories:

- **Product Ref. 13613:** hydraulic hose 1.82 m long, with Pioneer couplings

